

# PIONEER

Durable, Reliable, Quality Best Products

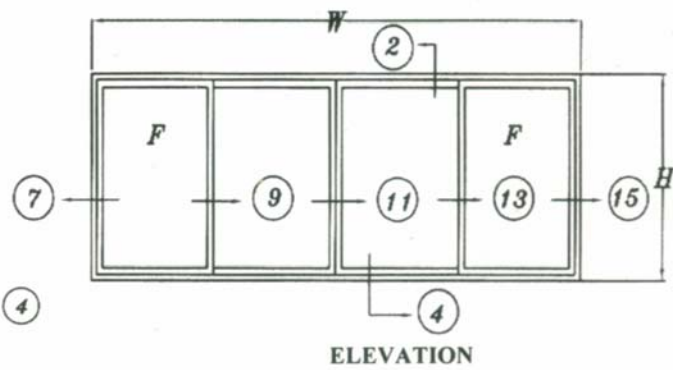

## Economy Sliding Window - Architectural Section -

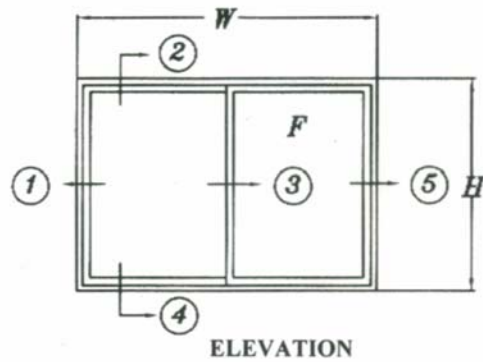
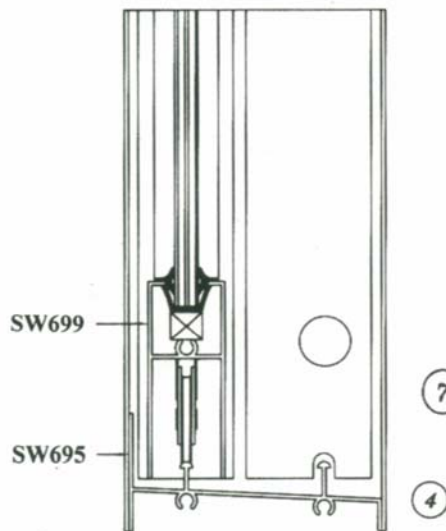
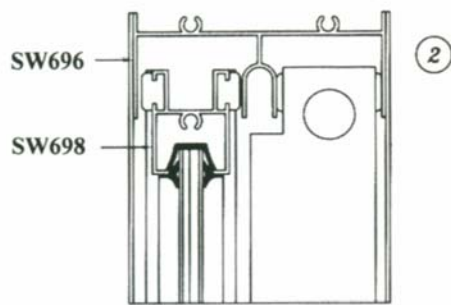

# PIONEER



*Durable, Reliable, Quality Best Products*

**Economy Sliding Window  
- Architectural Section -**

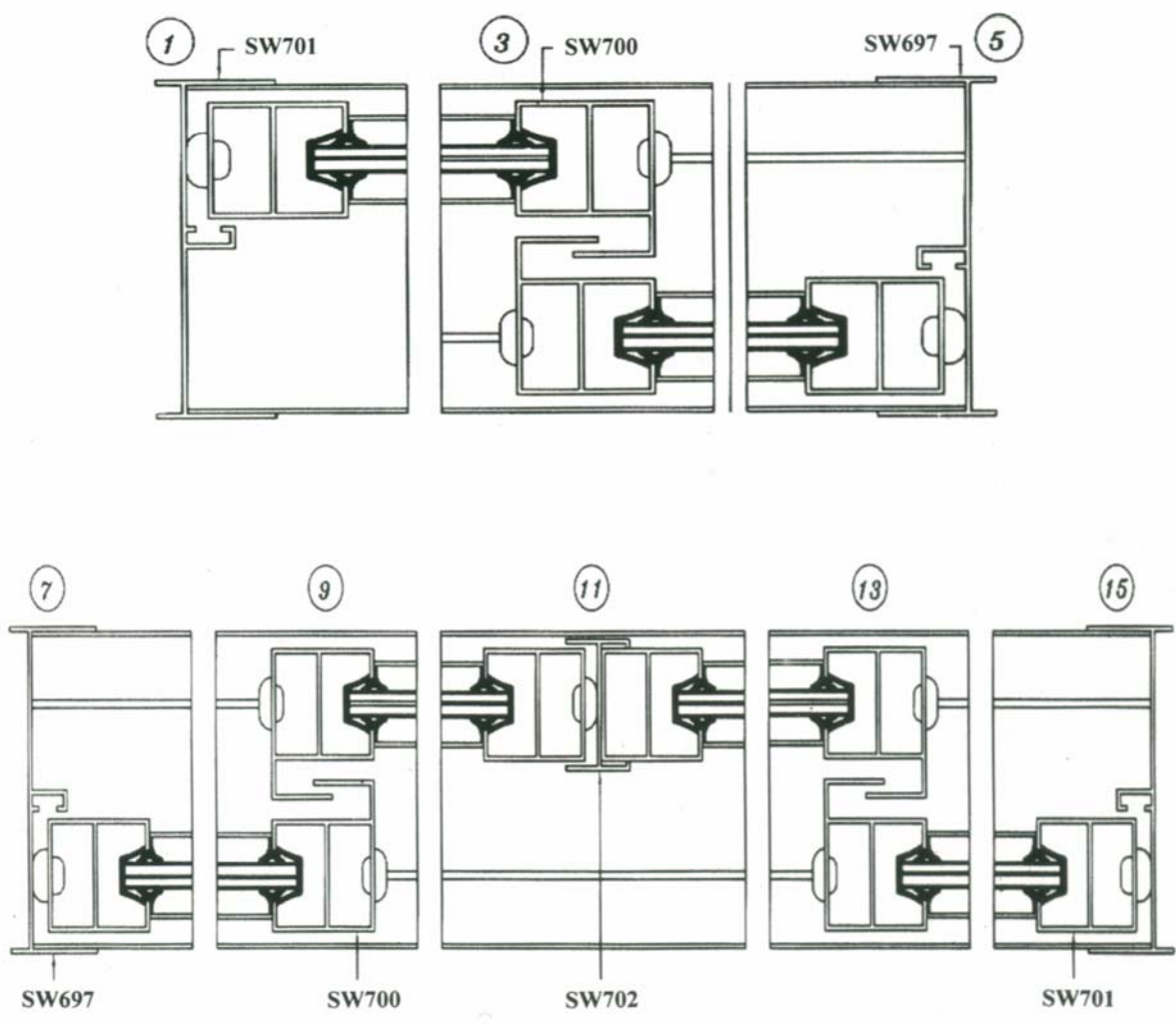

## Economy Sliding Window - Architectural Section -

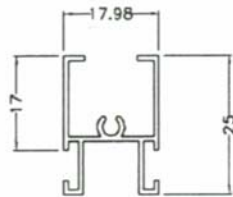

**SW698**  
0.239 kg/m  
AP:185 mm

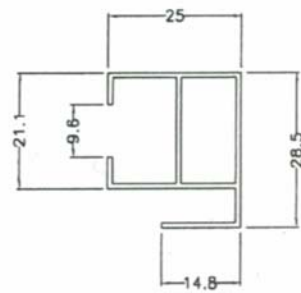

**SW700**  
0.293 kg/m  
AP:180 mm

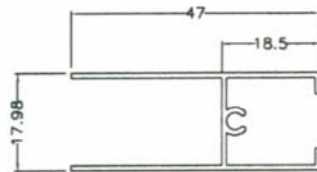

**SW699**  
0.299 kg/m  
AP:249 mm

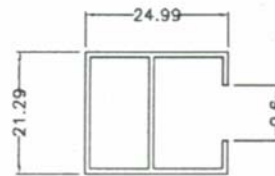

**SW701**  
0.244 kg/m  
AP:1387 mm

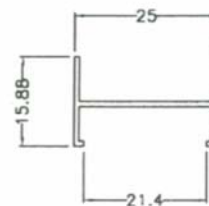

**SW702**  
0.139 kg/m  
AP:115 mm

# PIONEER

Durable, Reliable, Quality Best Products



## Economy Sliding Window - Architectural Section -

**SW697N**  
0.461 kg/m  
AP: 322 mm

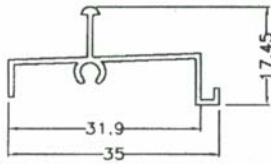
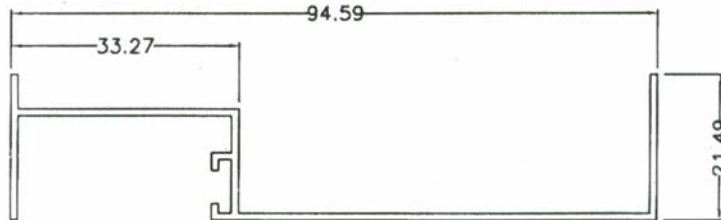

**SW076**  
0.218 kg/m  
AP: 139 mm

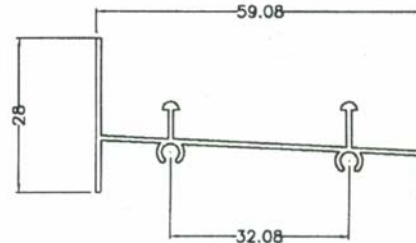

**SW695**  
0.356 kg/m  
AP: 252 mm

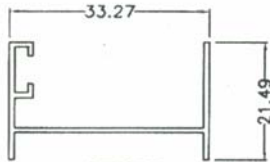

**SW077**  
0.245 kg/m  
AP: 170 mm

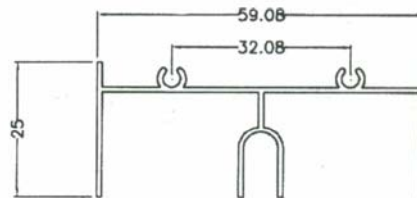

**SW696**  
0.393 kg/m  
AP: 316 mm

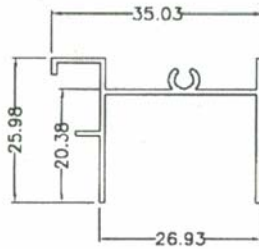

**SW078**  
0.280 kg/m  
AP: 199 mm

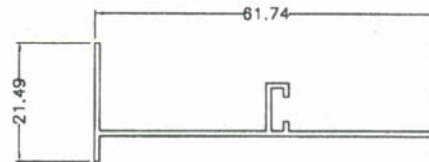

**SW697**  
0.306 kg/m  
AP: 238 mm

## Economy Sliding Door - Architectural Section -

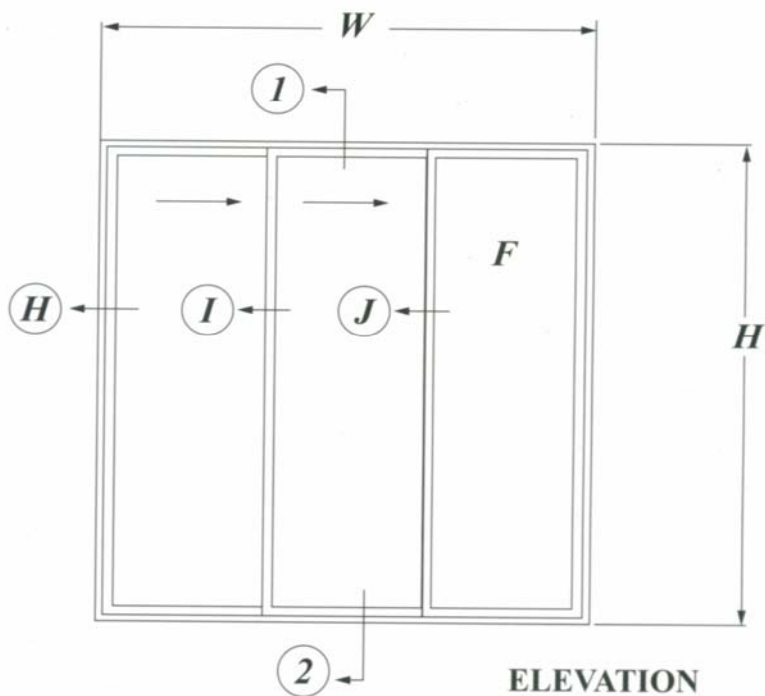
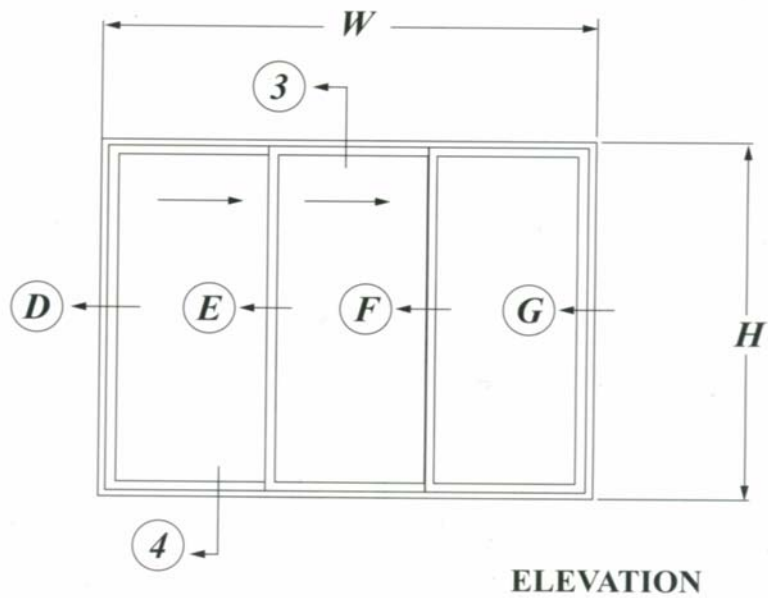

# PIONEER

Durable, Reliable, Quality Best Products



## Economy Sliding Door - Architectural Section -

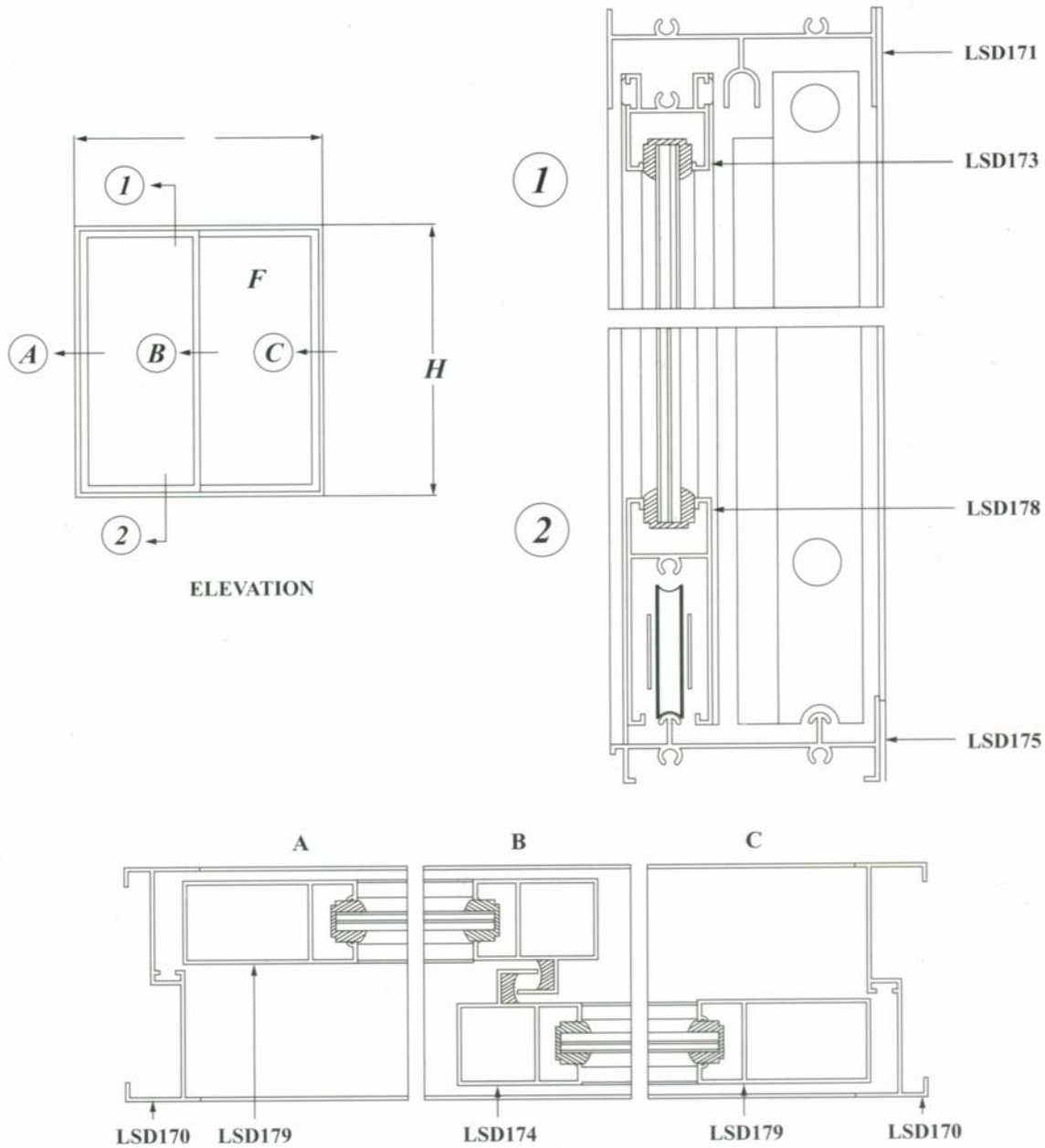

**Economy Sliding Door  
- Architectural Section -**

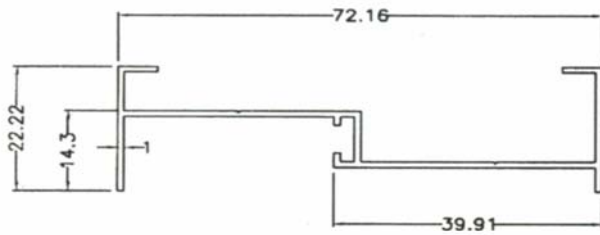

**SD170**  
0.385 kg/m  
AP:282 mm

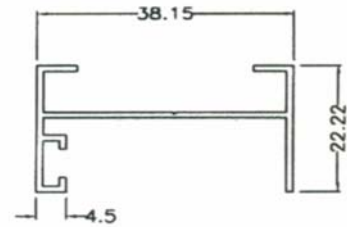

**SD169**  
0.278 kg/m  
AP:203 mm

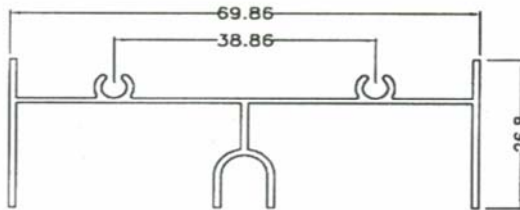

**SD171**  
0.508 kg/m  
AP:342 mm

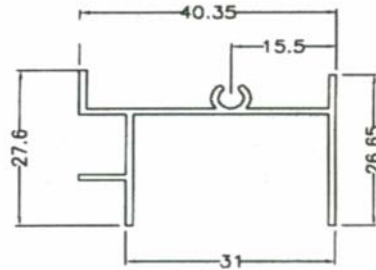

**SD172**  
0.334 kg/m  
AP:220 mm

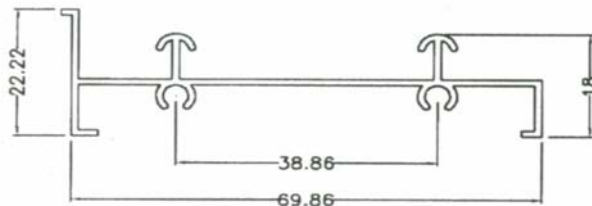

**SD175**  
0.439 kg/m  
AP:309 mm

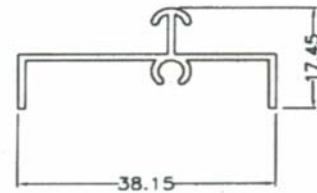

**SD176**  
0.276 kg/m  
AP:167 mm

## Economy Sliding Door - Architectural Section -

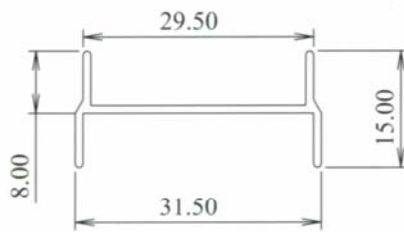

SD177  
0.188 kg/m  
AP : 117 mm

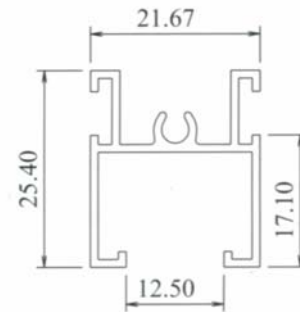

SD173  
0.288 kg/m  
AP : 200 mm

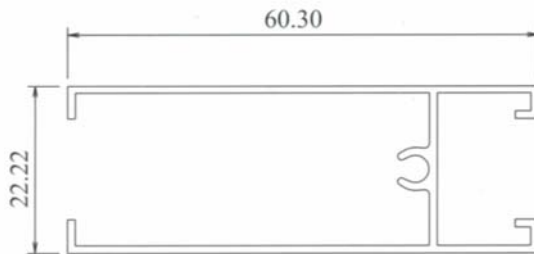

SD178  
0.475 kg/m  
AP : 343 mm

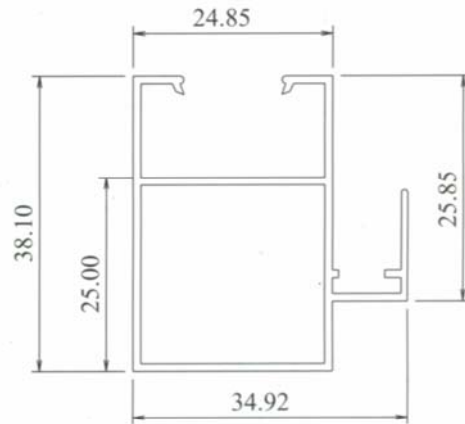

SD174  
0.451 kg/m  
AP : 218 mm

## Economy Sliding Door - Architectural Section -



SD179  
0.461 kg/m  
AP: 213 mm

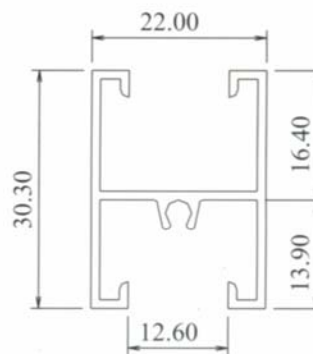

SD9819  
0.342 kg/m  
AP: 222 mm

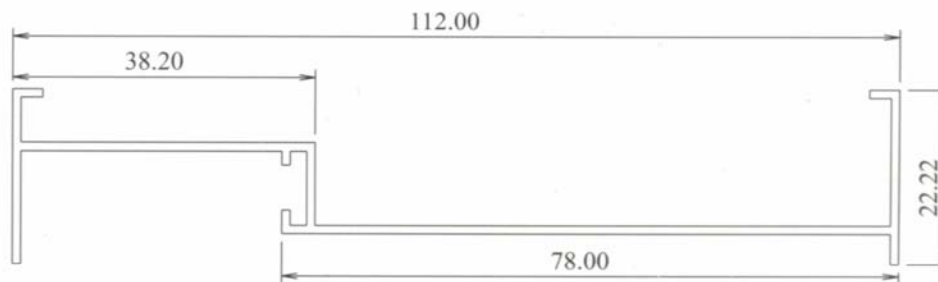

SD170N  
0.533 kg/m  
AP: 361 mm

# PIONEER

Durable, Reliable, Quality Best Products



## Standard Sliding Door - Architectural Section -

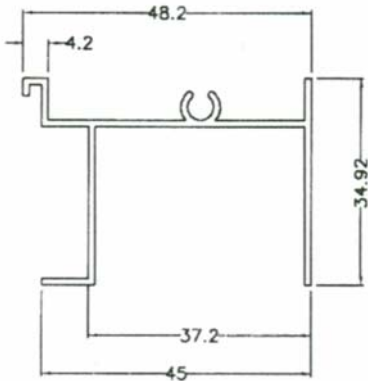

**SD399**  
0.391 kg/m  
AP:273 mm

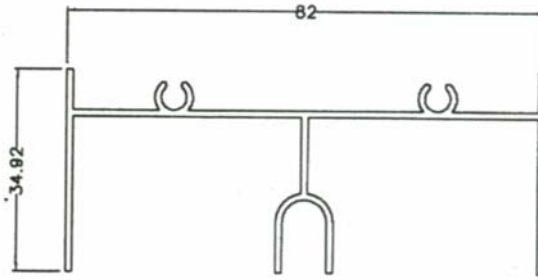

**SD964**  
0.640 kg/m  
AP:430 mm

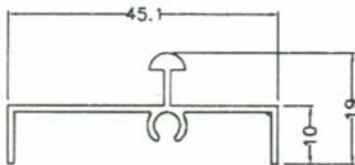

**SD143**  
0.286 kg/m  
AP:182 mm

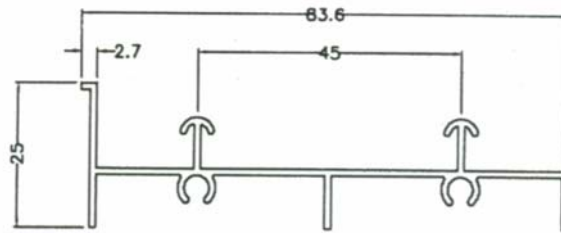

**SD090**  
0.548 kg/m  
AP:366 mm

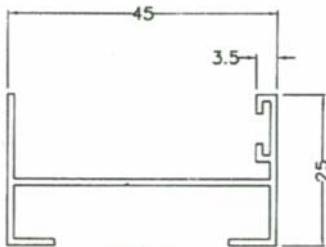

**SD144**  
0.329 kg/m  
AP:233 mm

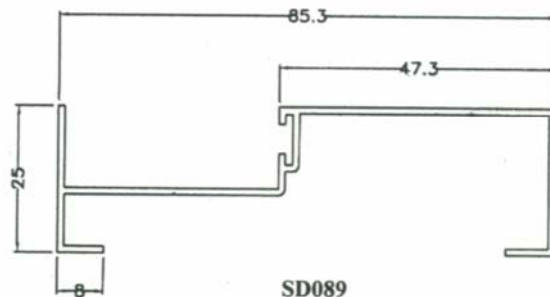

**SD089**  
0.512 kg/m  
AP:337 mm

# PIONEER



Durable, Reliable, Quality Best Products

## Standard Sliding Door - Architectural Section -



**SD093**  
0.712 kg/m  
AP:459 mm

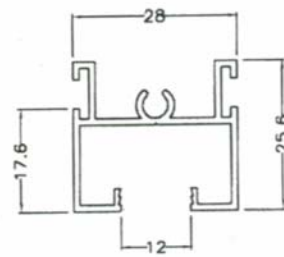

**SD092**  
0.352 kg/m  
AP:242 mm

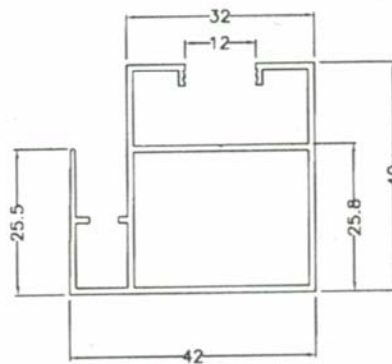

**SD094**  
0.591 kg/m  
AP:297 mm

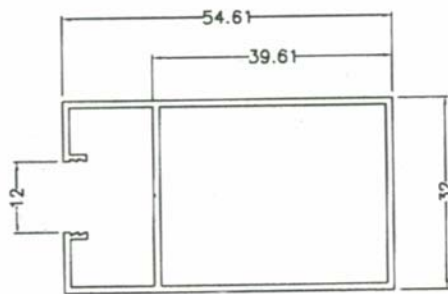

**SD095**  
0.578 kg/m  
AP:252 mm

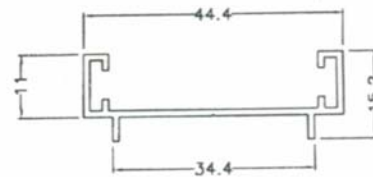

**SD096**  
0.249 kg/m  
AP:176 mm